

Unfolding Signatures of fast hydrogen and nitrogen atoms in near cathode emission with Optical Emission Spectroscopy

Bharathi magesh, Suraj sinha and S.Mukherji

*Institute for plasma research
Bhat, Gandhinagar, India*

Objectives

- ✓ To employ Optical Emission Spectroscopy (OES) on various emission zones in the DC glow discharge plasma nitriding in order to develop a comprehensive understanding on the mechanisms responsible for plasma nitriding.

Approach

- § Identify the dominant species in nitriding plasmas.
- § Study the spatial variation of the intensity of the nitriding species in various emission zones.
- § Probe the cathode glow and analyze these measurements to understand various governing mechanisms and properties of the species responsible for nitriding phenomena.
- § Compare with the predictions of modeling done for N₂-H₂ discharges
- § Dwell on the role of hydrogen in DC plasma nitriding using the OES measurements

Experimental setup

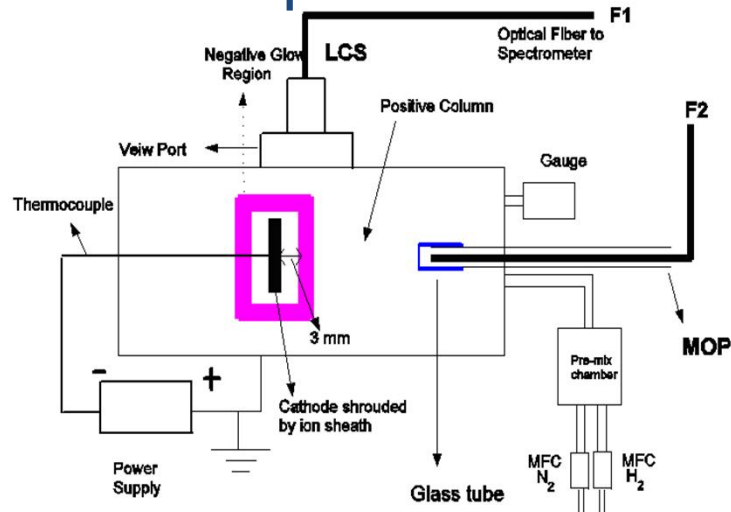

Optical setup

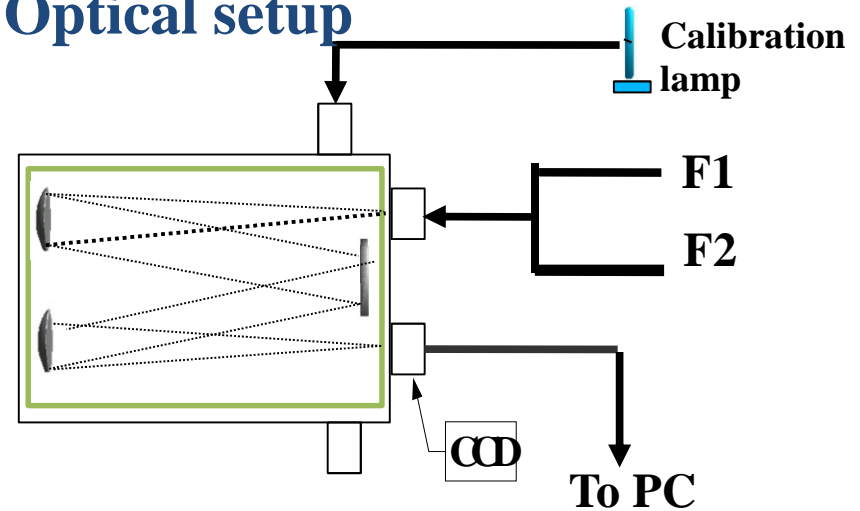

✓ 1 meter Czerny Turner imaging spectrograph with CCD detector with maximum wavelength resolution 0.025 nm.

✓ Light collection system (LCS): Bk7 Plano convex lens (F#3) & 1mm silica fiber

✓ Moving optical probe(MOP) : 6mm SS rod enclosed in a 4mm glass rod with 1mm fiber inside in it. Each end of the fibers are SMA terminated and the vacuum interface and moving mechanisms are shown in figure.2.

Figure.2

Date: 13/05/09
Optical Probe

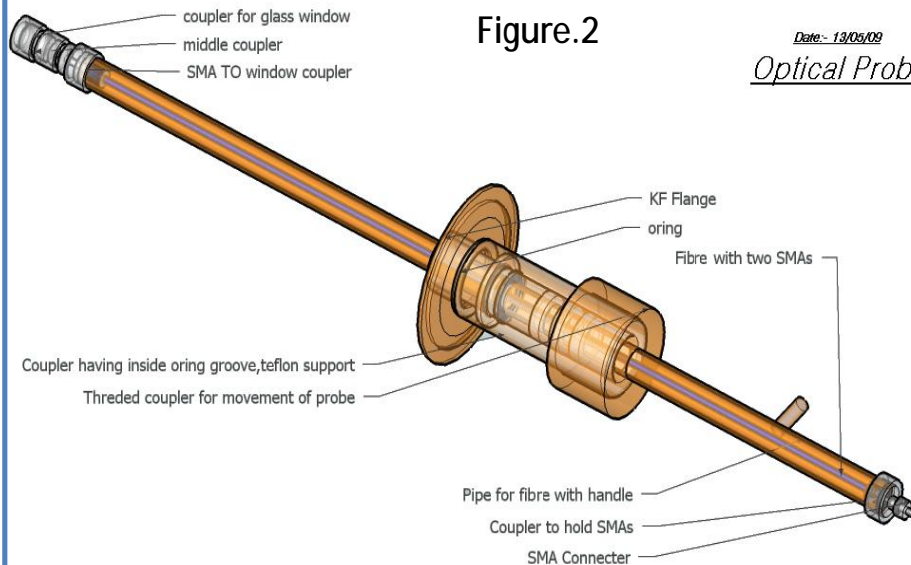

What was expected from MOP measurements?

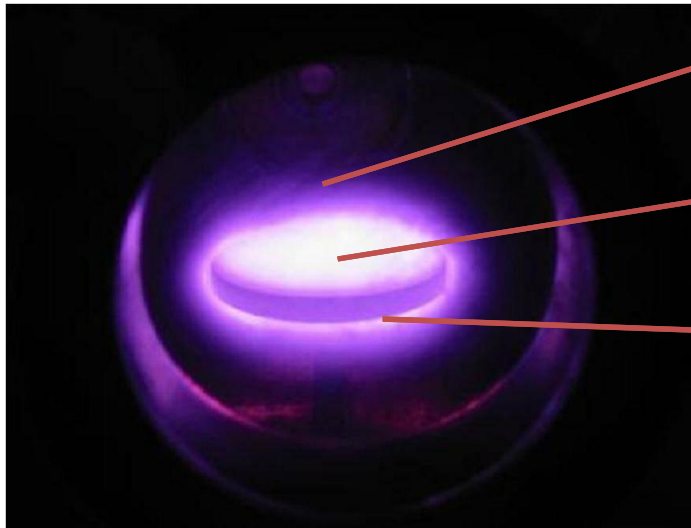

Positive column

Negative glow

Cathode glow

✓ MOP is at End-on and used for local profiles.

✓ LCS is Side-on and samples the cathode glow, negative glow and positive column simultaneously

Expectations

§ MOP can be used to find out the active species present near cathode

·
§ MOP can reveal the velocity distribution of the fast neutrals present in various emission zones by its line profile.

Speculation

MOP perturbs the discharge ? The answer is NO

1. MOP is floating.
2. The spectra did not show any difference in comparison with the LCS.
3. The effect of MOP near cathode can be neglected as it does not effect the nature of emissions from or near cathode

Experimental results at pressure 1mbar cathode @ -600V

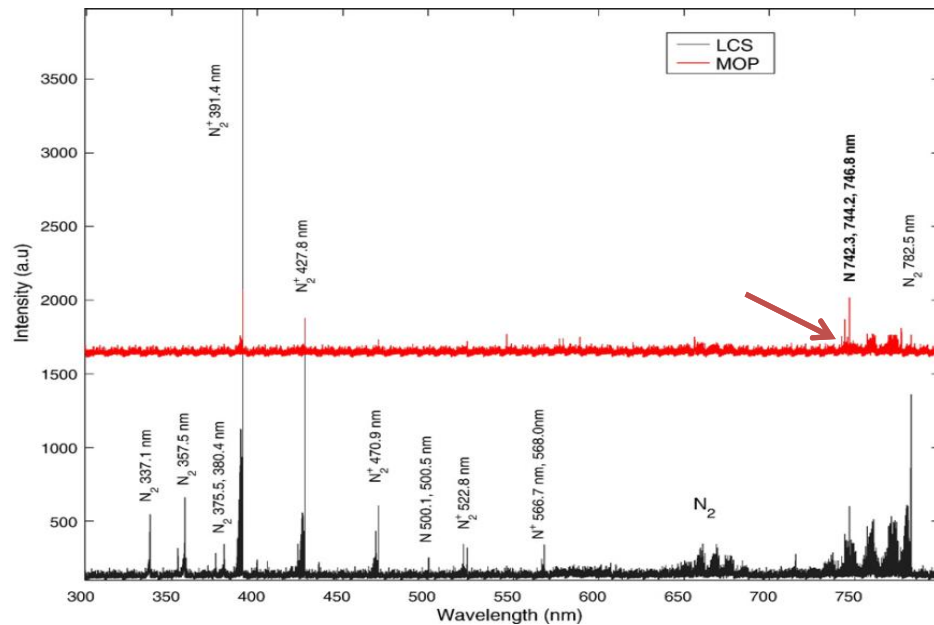

Conclusion-1:

Comparison of signals from LCS and MOP placed near to cathode shows (~3mm from cathode) only presence of nitrogen atomic lines near cathode.

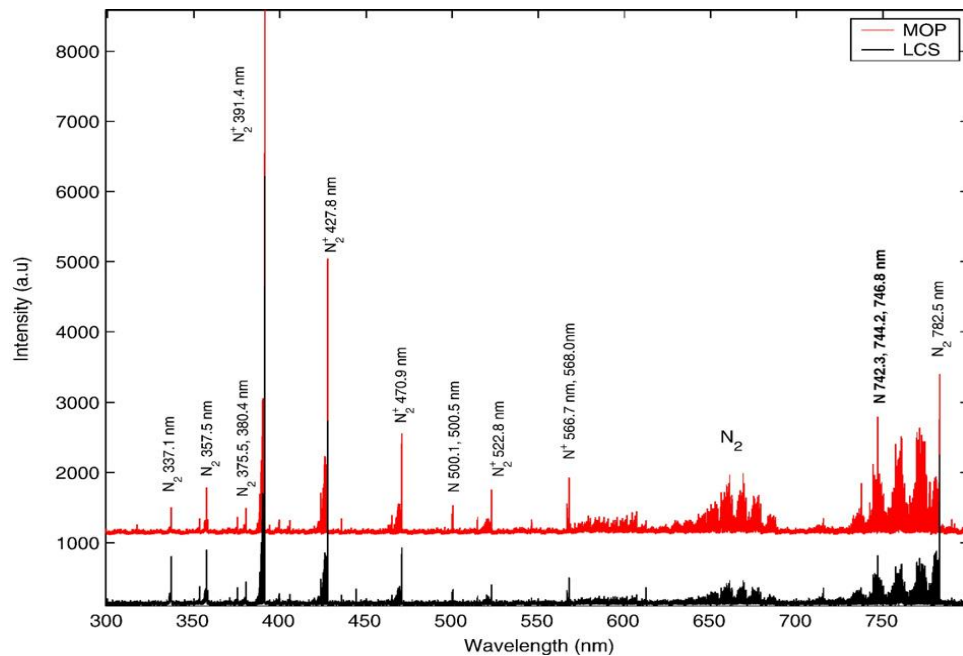

Conclusion-II

The intensity levels of spectra taken with LCS at side on and MOP at end on (viewing the whole discharge) are approximately identical. So MOP does not disturb plasma

Signature of fast nitrogen atoms near cathode

In the present work, a locally resolved OES technique was used to obtain near cathode (substrate) emission spectra for N₂-H₂ glow discharges.

It was observed that, along with N₂⁺ and N₂ lines, the characteristic atomic nitrogen lines and Hydrogen lines were the main emissions coming from the sheath region that shrouded the cathode.

A qualitative analysis of the spectral lines near the cathode has been done in order to understand the mechanism of plasma nitriding and the role played by the hydrogen in the nitriding process.

The decrease in local intensity of these atomic lines with hydrogen composition suggests that the effect of hydrogen is to enhance the sticking/adsorption of N on the cathode surface.

Experimental results contd

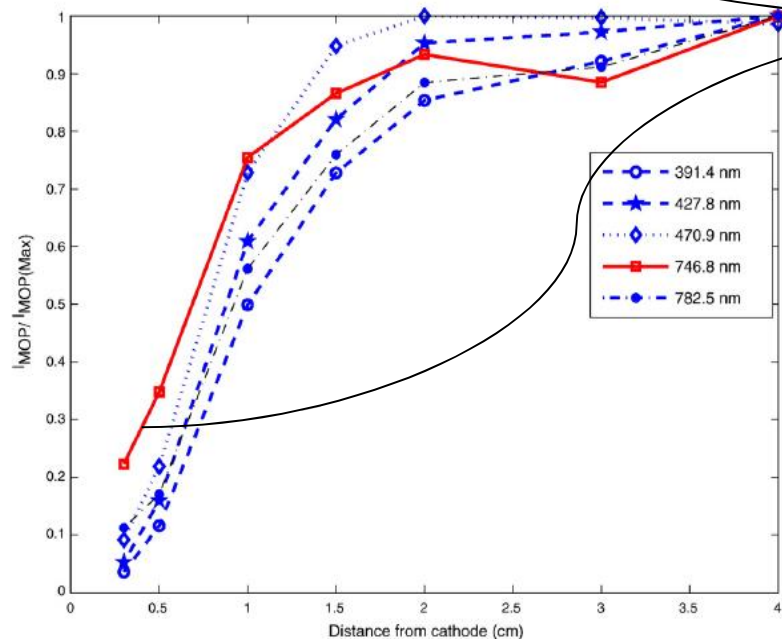
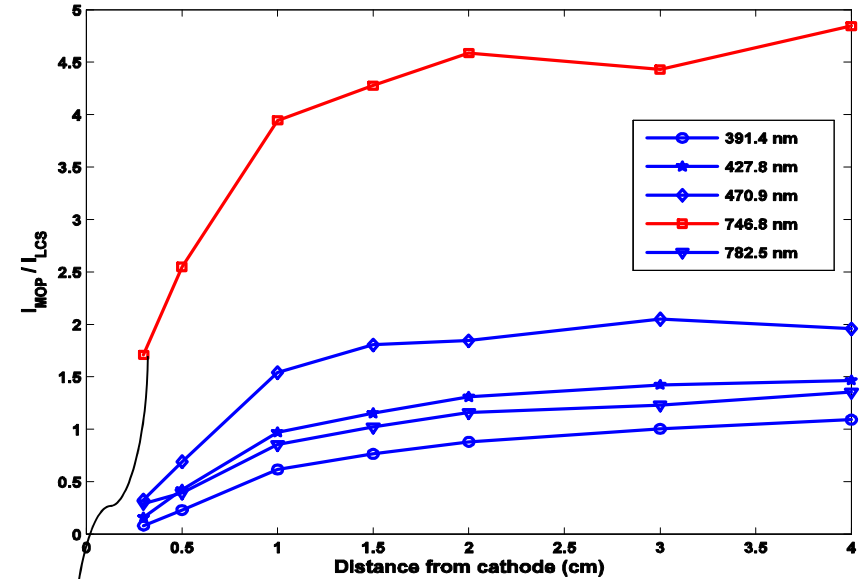
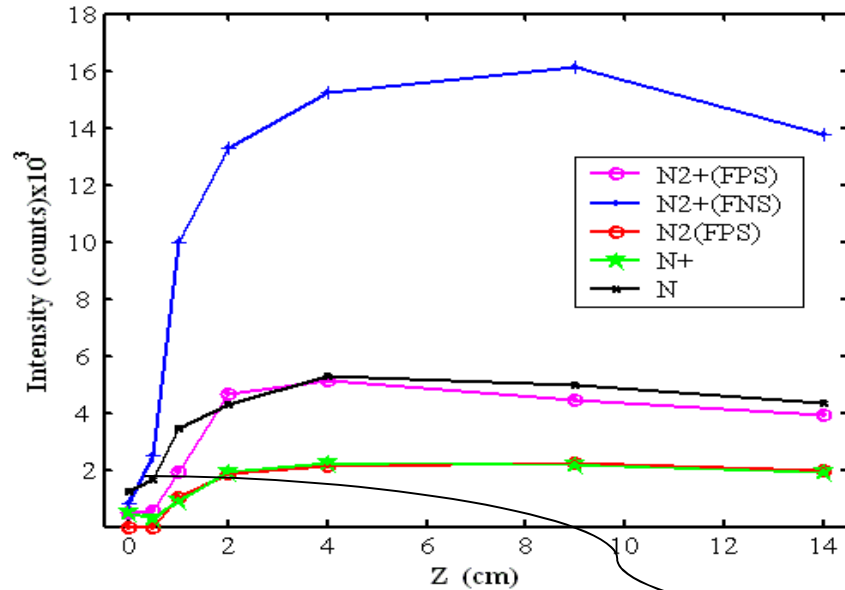

The MOP was moved from end on to negative glow than into the cathode sheath region . When MOP is at 3mm from cathode, it collected the emissions coming only from the sheath region and the emissions from the negative glow and bulk plasma were excluded.

Conclusion: *The intensity of N did not vanish unlike N₂⁺ and N₂ near cathode region*

What happened to N when 10-20% of H₂ is added?

This observation is using @ MOP at negative glow

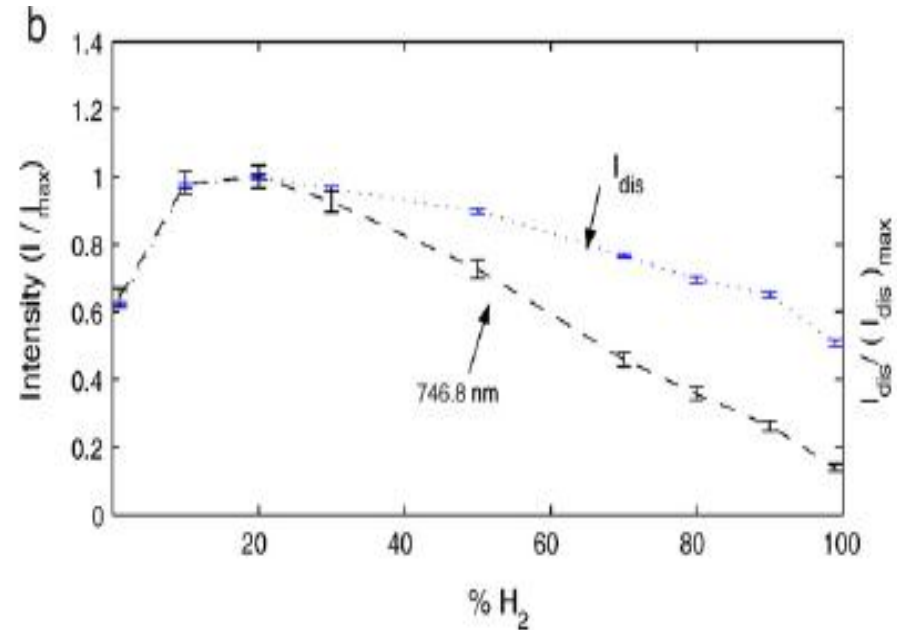
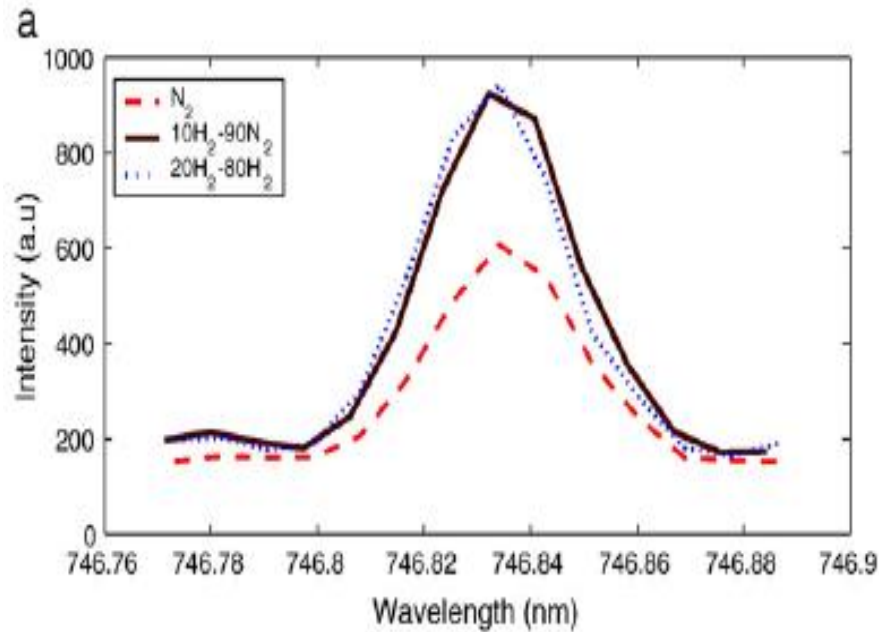

Observations :

Figure a) The intensity of atomic nitrogen line (746.8 nm), observed from LCS, increases with the hydrogen concentration up to 20% in the gas composition.

(b) The intensity observed with LCS and discharge current is plotted for all N₂-H₂ compositions. The intensity (I / I_{max}) and discharge current [$I_{dis} / (I_{dis})_{max}$] profile shows the same trend. The intensity as well as the discharge current is maximum at 80% N₂-20% H₂. The intensity gradually falls with a further increase in the hydrogen composition.

The measurements of MOP at 3mm from cathode revealed something different

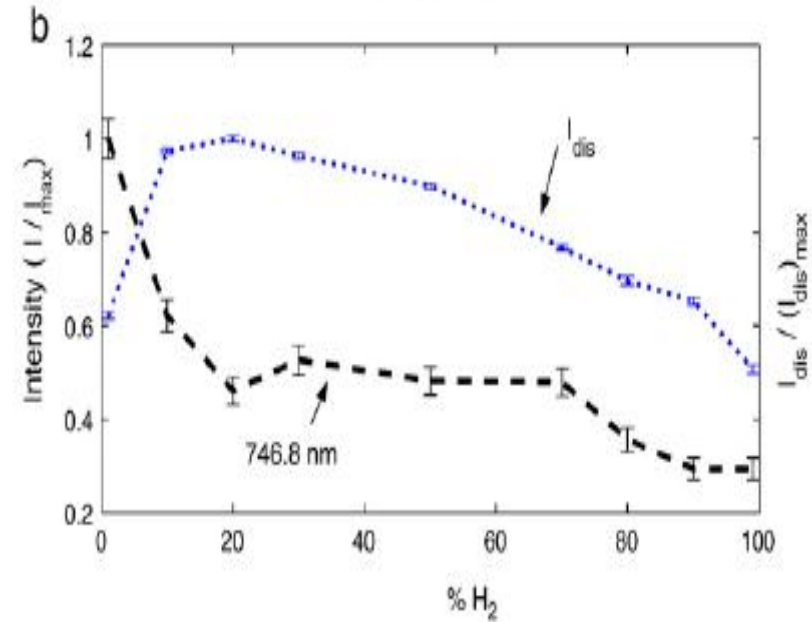
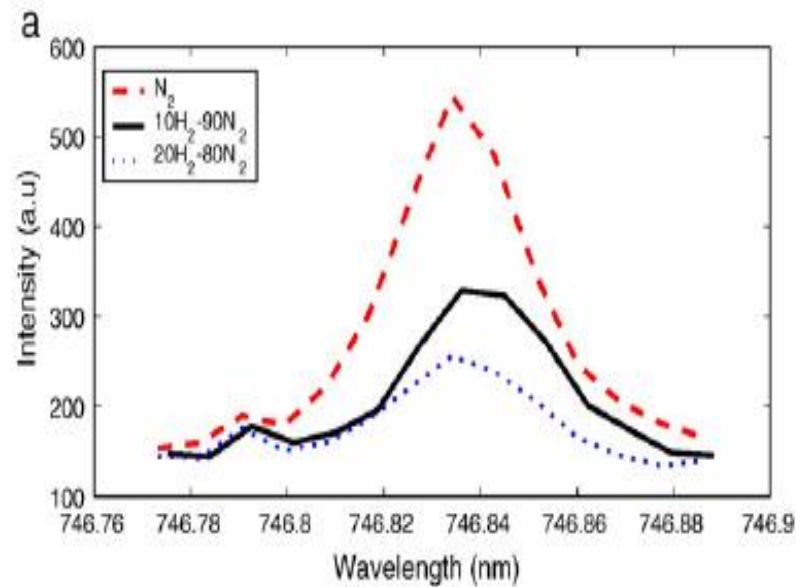

Observation-II:

a) The MOP was placed inside the sheath region (~3 mm) so that it collects emissions coming from the sheath region shrouding the cathode. The spectra of 746.8 nm line for pure N₂, 90%N₂-10%H₂ and 80%N₂-20%H₂ are shown. The spectra of N line shows a decrease in intensity with increase in hydrogen concentration. The intensity falls rapidly with hydrogen fraction up to 20%.

(b) The intensity observed from the MOP and discharge current for all N₂-H₂ compositions are shown. The discharge current has maxima at 20% H₂, while intensity is minimum at this point.

Modeling of N₂ discharge sheaths

Generally it is assumed that the fast positive ions accelerate by the applied bias in the sheath are responsible for doing the modification at substrate surface. If sheath is collisional, ions and neutrals reaching the substrate surface have velocity distribution.

The parameters affecting the surface modification are:

- § Energy of the incident particle
- § Particle flux density
- § Energy flux density
- § Temperature of the substrate

To estimate the contribution of ions and neutrals to the power influx a theoretical model is proposed, which can show ion, neutral velocity and their flux at cathode.

CM model of sheath

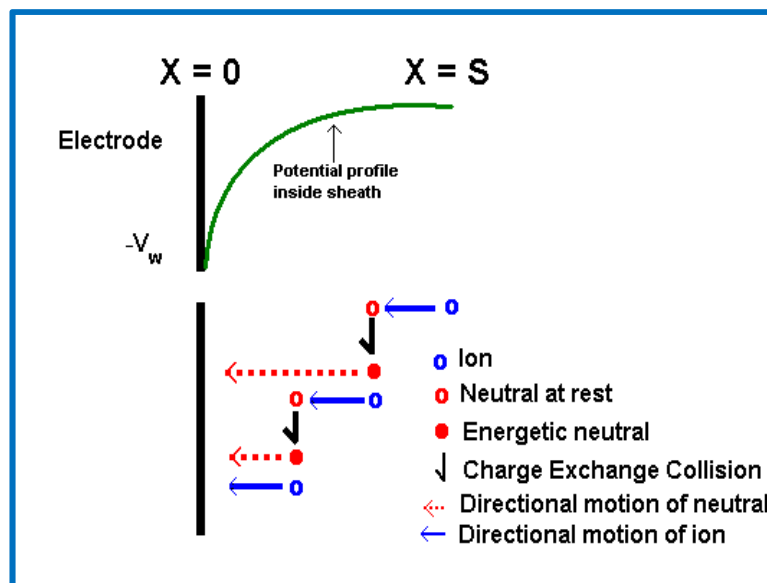

Model is described in the references

- 1) K. S. Suraj, P. Bharathi, V. Prahlad and S. Mukherji, *Surf. Coat. Technol*, 202, 301 (2007).
- 2) K. S. Suraj and S. Mukherjee, *Phys. Plasmas* 12, 113502 (2005)
- 3) K. S. Suraj, S. Mukherjee, *Surf. Coat. Technol*, 196, 267, (2005).

Few important results from CM model

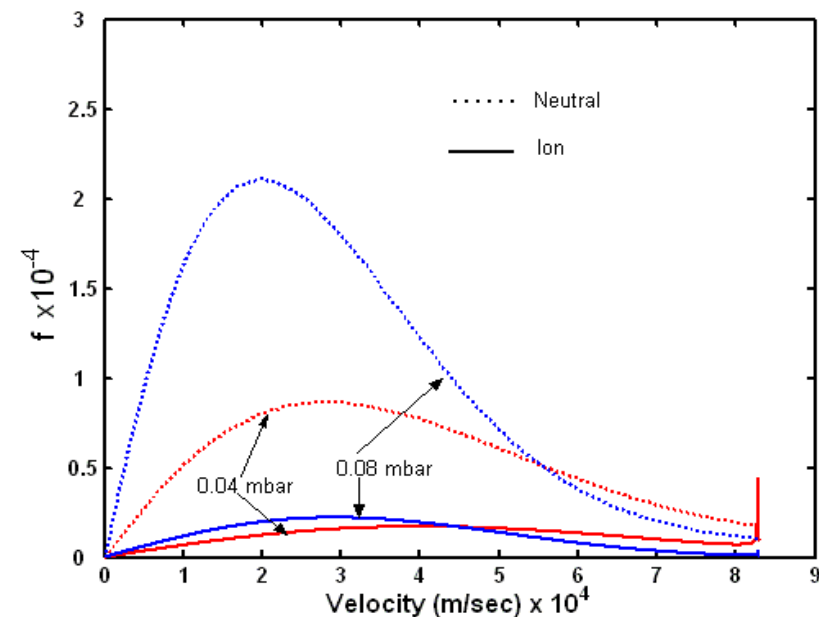
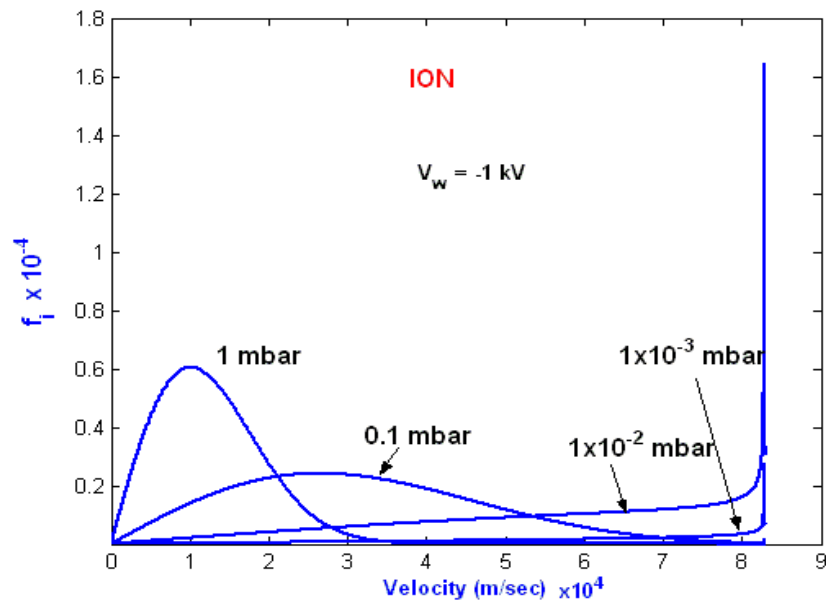

§ At low pressures, sheath is nearly collisionless, and ions reach cathode as a mono-energetic beam. With increase in pressure, the collisions dominate and velocity peaks towards lower values.

§ Neutral distribution have higher value than the Ion distribution for weakly collisional sheath.

§ The contribution of neutrals to particle flux and energy flux is much larger than the ions.

Hence the role of energetic neutrals is significant in plasma based surface modification processes.

Role of hydrogen in glow discharge plasma nitriding mechanism

The following three step mechanism is proposed on the basis of the experimental results

- 1) N_2^+ is the main species in the plasma region as showed by OES at negative glow. It gains energy through the cathode fall region, as the ion sheath is collisional, N_2^+ will undergo charge exchange collisions with background N_2 and generate fast N_2 molecules as per the CM model.
- 2) These fast molecules have now sufficiently high kinetic energy(>20eV) to undergo *dissociative chemisorptions* at the cathode surface and produces abundant atomic nitrogen near the cathode surface .
- 3) In the presence of hydrogen, there is a *decrease in work function of iron*. Usually the decrease in work function is associated with an increase in sticking coefficient. Thus, in the presence of hydrogen, atomic nitrogen formed near/on the cathode has higher probability of sticking to the cathode surface. If this is true, a decrease in intensity of N is expected which is confirmed by the OES done near cathode.

Signature of fast hydrogen atoms

§The spectroscopic investigations of hydrogen discharges in DC, hollow cathode, RF and multi-cusp sources are very useful.

§Study of these discharges has many important applications in the field of plasma surface interactions, low temperature electrical discharges used for plasma processing and fusion plasmas.

§Information about these processes inside the sheath could be obtained by studying the differences in characteristics of intensity profiles of the excited species from cathode glow and negative glow region.

§In this work, we present the investigations carried out on the asymmetric Balmer- α lines, obtained at different locations along the discharge axis and explained the formation mechanisms of the energetic neutrals in various emission zones

Phelps CM model

The energetic broad wing is due to the following Charge Exchange reaction



Excited neutral do not form on excited states on the surface of the cathode. They are excited during their transit back to the volume of the discharge by interacting with the background gas.



Z.Lj.Petrovic, B.M.Jelenkovic and A.V.Phelps, *Phy.Rev.Lett* 68, 325 (1992).

What was observed and thought earlier in hydrogen discharges & Phelps CM model

Characteristic observations in Hydrogen discharge

§ The intensity profiles of fast neutral is maximum very near to cathode in comparison with the intensity at negative glow .

§ Asymmetric broad energetic pedestal (sometimes corresponding to the applied voltage) in all observed line profiles when the observations are made along discharge axis.

§ No asymmetry when the profiles are observed perpendicular to discharge axis.

Speculations /proposals

§ The asymmetry is due to large back scattering neutral flux from the cathode .

§ Large number of excited neutrals are borne on the surface so intensity is maximum near the surface.

§ The energy of the backscattered neutral do not attenuate

Overlaid

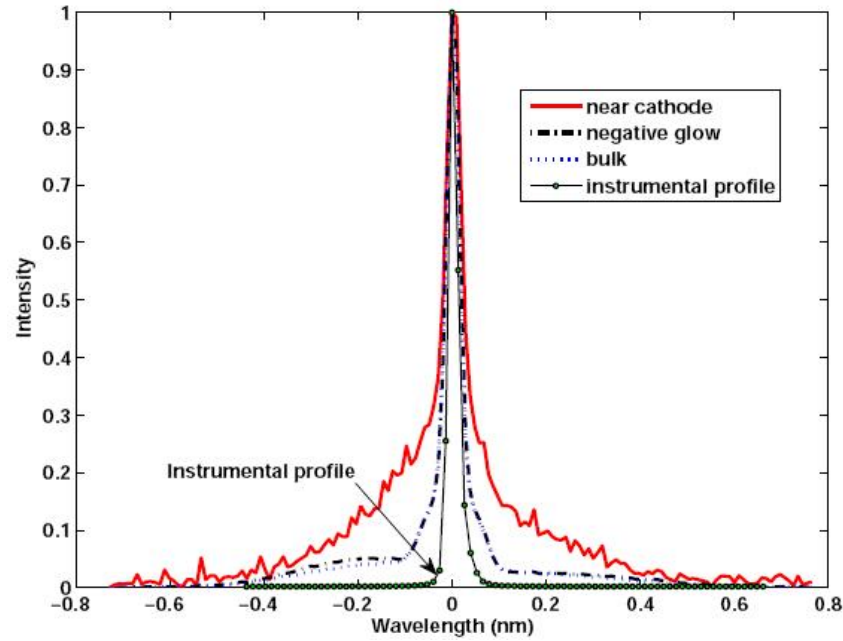

MOP at end-on

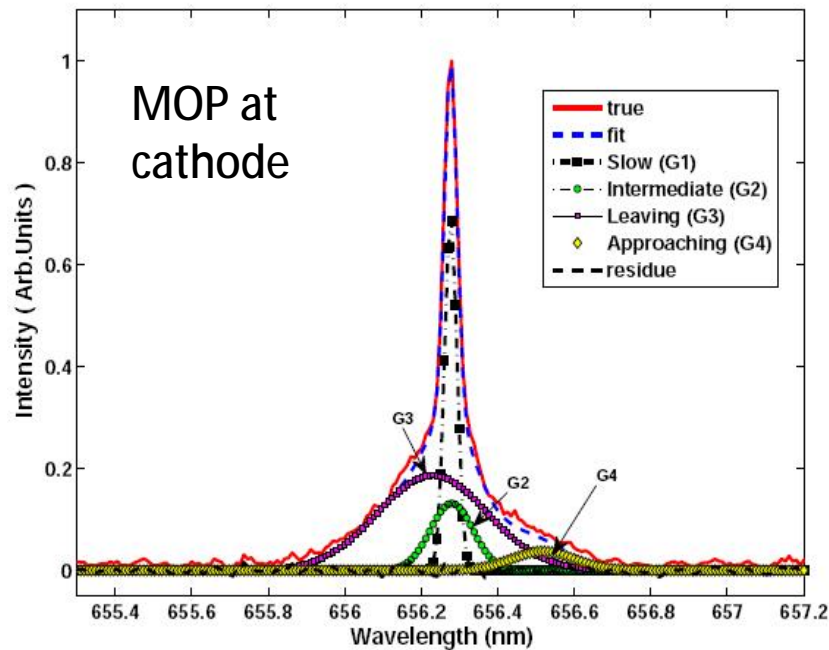
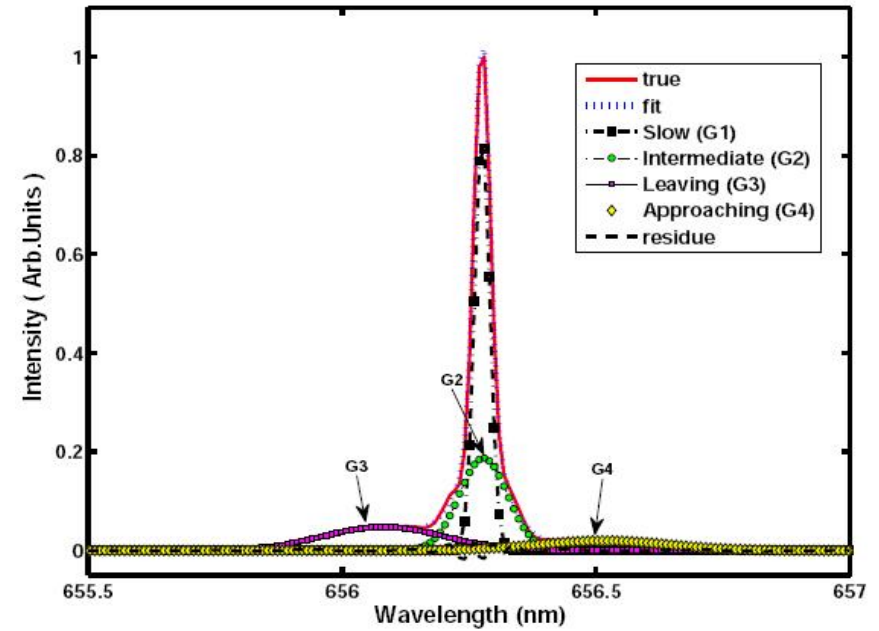

The profiles were taken at pure H₂ discharge conditions : pressure : 1mbar , cathode bias : -600V.

The mean energy of fast neutrals is experimentally estimated by using the Doppler broadening given by :

$$E = \frac{1}{2} m c^2 \left(\frac{\Delta I_D}{I_0} \right)$$

Line profile analysis results

Location of Probes	MOP			LCS
	<i>3 mm</i>	40mm	140mm	(End-on)
Mean energy of slow group (eV) E1	<i>1.61±0.0006</i>	1.36±0.0002	1.36±0.0001	1.34±0.0001
Mean energy of intermediate group(eV) E2	<i>18.65 ±0.09</i>	13.56±0.0009	14.32±0.001	13.82±0.0039
Mean energy of leaving group(eV) E3	<i>123.16± 0.07</i>	83.36±0.0087	83.3±0.019	85.50±0.04
Mean energy of approaching group(eV) E4	<i>39.95± 0.45</i>	99.25±0.028	98.62±0.038	101.42±0.15
Doppler Shift of G1(nm)	<i>-0.0027</i>	-0.0041	0.0043	-0.005
Doppler Shift G2(nm)	<i>0.0003</i>	-0.0016	-0.006	-0.0034
Doppler Shift G3(nm)	<i>0.05</i>	-0.198	-0.177	-0.208
Doppler Shift G4(nm)	<i>0.27</i>	0.23	0.21	0.269
I_1/I_{total} (%)	<i>23</i>	42	44	42
I_2/I_{total} (%)	<i>15</i>	29	31	28
I_3/I_{total} (%)	<i>55</i>	18	15	20
I_4/G_{total} (%)	<i>6</i>	9	8	8.8

Confirmation of Phelps CM model for high pressure hydrogen glow discharges

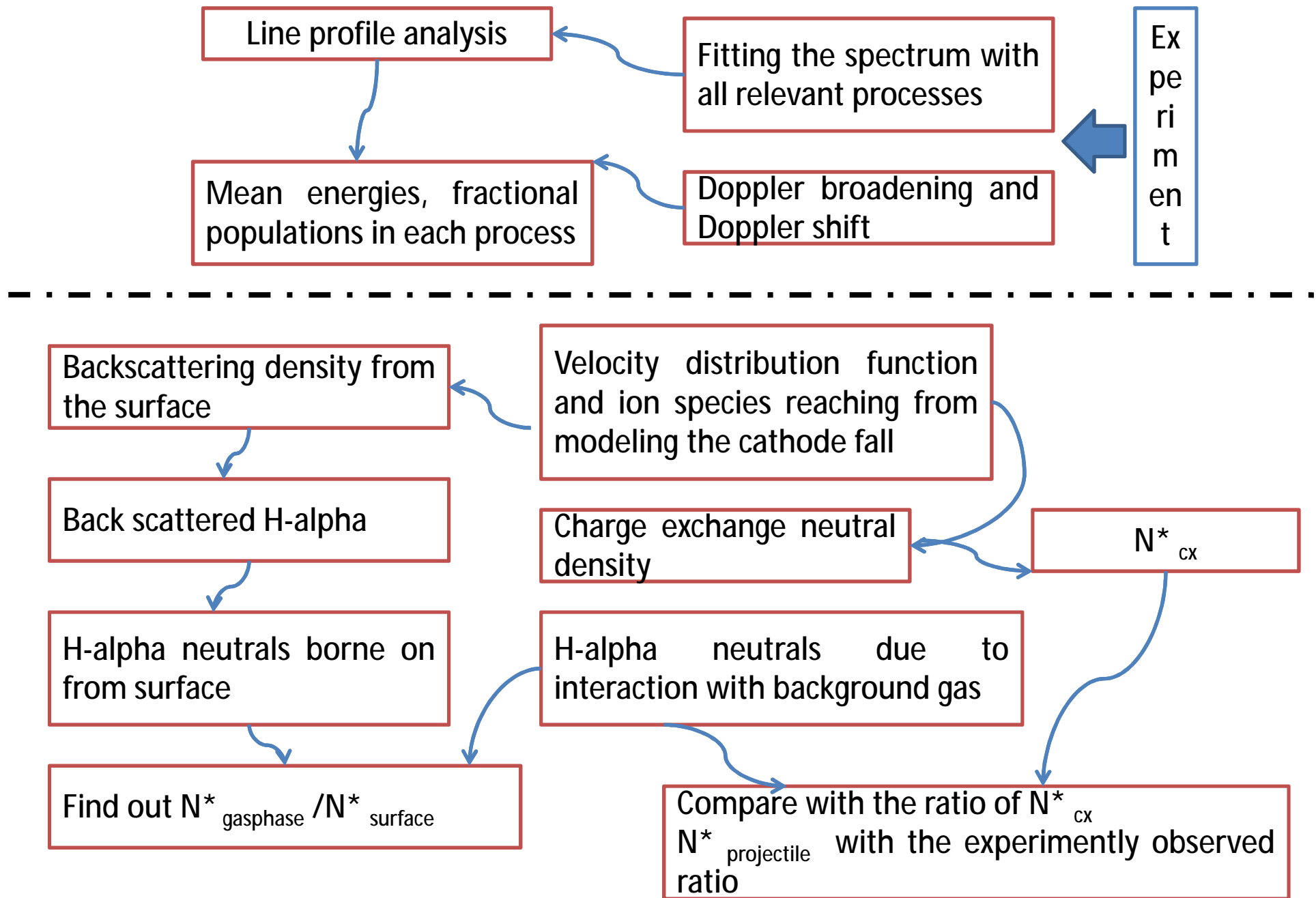

Results and conclusions

Ion Species	Mean velocity $\langle V_i \rangle \times 10^6$ (m/s)	Mean energy $\langle E_i \rangle$ (eV)	Ion concentration Ni (10^8cm^{-3})
H ⁺	17.5	195	2.0
H ₂ ⁺	0.84	75	2.9
H ₃ ⁺	0.47	43	3.4

Density of back scattered neutrals (cm^{-3})	$N_b \sim 1.2 \times 10^9$
H-alpha density (surface) (cm^{-3})	$N_H^{\text{surface}} [n=3] \sim 1.8 \times 10^5$
H-alpha density (Gas phase) (cm^{-3})	$N_H^{\text{gas phase}} [n=3] \sim 7 \times 10^6$
H-alpha density (Charge exchange) (cm^{-3})	$N_H^{\text{CX}} [n=3] \sim 9 \times 10^5$

- ✓ The observed profiles fit more accurately with a four component Gaussian suggesting four classes of H atoms.
- ✓ The very fast hydrogen atoms in cathode glow region have energy ~ 130 eV and the fractional population was $\sim 55\%$, resulting in asymmetric profile. These values reduced to ~ 90 eV and $\sim 20\%$ when measured at negative glow and other locations of the discharge.
- ✓ The density of H_α produced from the excitations due to charge exchange and due to interaction between back scattered neutrals with the back ground gas are not same and are different by a factor of ~ 8 . This value is in agreement with our experimentally observed population ratios.
- ✓ The ratio of the excited fast neutrals produced from the interaction of the backscattered neutral with the back ground gas to the excited backscattered neutral borne on the surface is $< 1\%$. Which confirms the Phelps model suggested for Hydrogen discharges .

References

1. A possible new mechanism for glow discharge plasma nitriding, K.S.Suraj, P.Bharathi and S.Mukherji, to be submitted to *Applied physics letters*.
2. P.Bharathi and V.Prahlad, *Journal of Applied Physics* ,vol.107, p.123307(2010).
3. P.Bharathi, K.S.Suraj, V.Prahlad, S.Mukherji and P.Vasu, *Physics of plasmas*, vol.16,p.053504 (2009).